

## **GBAS - Ground Based Augmentation System, an Italian Experience**

Salvatore GAGLIONE \*, [Mario VULTAGGIO\\*](mailto:Mario.Vultaggio@uniparthenope.it)

(\*) (\*\*) - Dipartimento di Scienze Applicate - Università degli studi di Napoli "Parthenope" – [mario.vultaggio@uniparthenope.it](mailto:mario.vultaggio@uniparthenope.it) , [salvatore.gaglione@uniparthenope.it](mailto:salvatore.gaglione@uniparthenope.it).

### **Abstract**

The GNSS (Global Navigation Satellite Systems) are not sufficient to support Air Navigation in specific applications; so it is necessary to introduce Augmentation Systems. In the last years the European Scientific Community are focusing on Augmentation Systems based on Satellite infrastructure (SBAS - Satellite Based Augmentation System) and on Ground based ones (GBAS - Ground Based Augmentation System).

The purpose of this work is to verify GBAS performance. We started from a data set of measurements carried out at the GBAS of Milan-Linate where we work on a ground installation (GMS – Ground Monitoring Station) that supervise the GBAS signal and that represent, for our purposes, the Aircraft subsystem. So the set of data collected is to be considered in RTK mode and after the measures session we processed them with the software PEGASUS v 4.0. Some results on availability, integrity and accuracy are reported and discussed.

### **1 - Background**

Since 1993, the civil aviation community through RTCA (*Radio Technical Commission for Aeronautics*) and the ICAO (*International Civil Air Navigation Organization*) have been working on the definition of GNSS augmentation systems that will provide improved levels of accuracy and integrity. These augmentation systems have been classified into three distinct groups: Space Based Augmentation Systems (SBAS), Ground Based Augmentation Systems (GBAS) and Aircraft Based Augmentation Systems (ABAS).

RTCA and ICAO diligently provided performance requirements and standards for GNSS and GNSS augmentation systems. The ICAO Standards and Recommended Practices (SARPS) includes standards for SBAS, GBAS and ABAS as well as standards for GPS and GLONASS. The SARPS are intended to establish signal in space standards and performance standards such that interoperability is supported around the world.

Without establishing standards for the airborne equipment, ICAO has adopted an alternative approach by stating the requirements that all kinds of GNSS receiver and GBAS equipment have to satisfy.

These are defined RNP (*Required Navigation Performance*) and are specified for each flight phase:

- NPA (*Non Precision Approach*) or with RNP 0.3 NM;
- *Approach with Vertical Guidance* with RNP 0.3/125 (feet);
- *Approach with Vertical Guidance* with RNP 0.03/50;
- CAT I with RNP 0.02/40;
- CAT II with RNP 0.01/15;
- CAT III with RNP 0.003/0.

Figure 1 compares the Required Navigation Performance (RNP) per phase of flight with the existing or expected GNSS system performance.

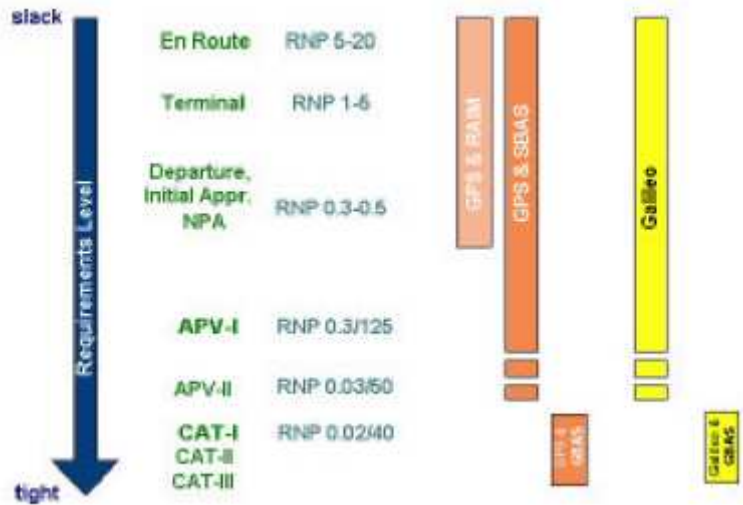

**Figure 1 - Aviation Phases of Flight versus GNSS Performance**

An RNP is associated to the flight phase in function of the following parameters:

**Table 1 – RNP [2][3]**

RNP	Cat.	Accuracy (Hor./ Ver.)	Integrity (Prob.. and Alert Time)	Availability.	Continuity
0.3/125	APV I	± 0.3 NM 125 ft	$1 - 10^{-5} / h$	0.95	$1 - 10^{-4} / h$
0.03/50	APV II	± 0.03 NM 50 ft	$1 - 3.5 \times 10^{-7} / h$ 6 sec.	0.9975	$1 - 10^{-5} / h$
0.02/40	Cat. I	± 0.02 NM 40 ft	$1 - 3.5 \times 10^{-7} / h$ 6 sec.	0.9975	$1 - 10^{-5} / h$
0.01/15	Cat. II	± 0.01 NM 15 ft	$1 - 2.5 \times 10^{-9} / h$ 1 sec.	0.9985	$1 - 6 \times 10^{-6} / h$
0.003/0	Cat. III	± 0.003 NM	$1 - 2 \times 10^{-9} / h$ 1 sec.	0.999	$1 - 6 \times 10^{-6} / h$

The 95<sup>th</sup> percentile values for GNSS position errors are those required for the intended operation at the lowest height above threshold (HAT), if applicable. The definition of the integrity requirement includes an alert limit against which the requirement can be assessed.

The civil aviation community rightly consider that GNSS will support air navigation and its requirements only with a suitable augmentation system (e.g. GBAS).

**2 - GBAS**

[4][5]The Ground-Based Augmentation System (GBAS) is a safety-critical system that augments the GPS Standard Positioning Service and provides enhanced levels of service supporting all phases of approach, landing, departure and surface operations within its area of coverage. GBAS will initially be applied to the approach phase of flight as an alternative to ILS CAT I.

The GBAS system consists of three primary subsystems, as shown in the figure 2:

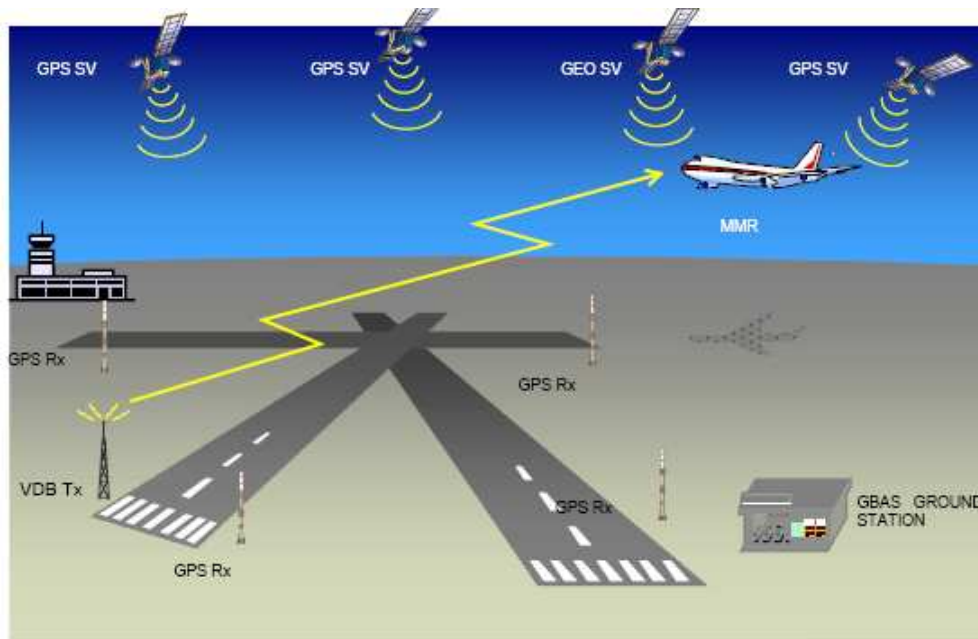

**Figure 2 - GBAS overview**

- GNSS Satellite subsystem. It produces the ranging signals and navigation messages. The satellite signals received by the GNSS receivers are subject to various error sources. Some of these error sources are intended to be compensated through the use of differential techniques in the GBAS system.
- GBAS ground subsystem, which uses two or more GNSS receivers. It collects pseudoranges for all GNSS satellites in view and computes and broadcasts differential corrections and integrity-related information for them based on its own surveyed position. These high integrity computed corrections are transmitted from the ground system via a Very High Frequency (VHF) Data Broadcast (VDB) in the band 108 to 117,975 MHz. The lowest selectable frequency is 108.025 MHz and the highest one 117.950, with a separation between frequencies (channel spacing) of 25 kHz. The transmitter broadcasts pseudorange corrections, integrity parameters and various locally relevant data such as Final Approach Segment (FAS) data, referenced to the World Geodetic System (WGS-84). When it uses an antenna with an omni directional pattern, the ground station has the capability to support multiple runway end approaches. Consequently, the broadcast includes various approach segments (FAS) which consist of Path Points describing approaches for each related runway, the FAS Vertical Alert Limit/Approach Status and the FAS Lateral Alert Limit/Approach Status.
- Aircraft subsystem. Aircraft subsystems within the area of coverage of the ground station may use the broadcast corrections to compute their own measurements in line with the differential principle. After selection of the desired FAS for the landing runway, the differentially corrected position is used to generate navigation guidance signals. Those are lateral and vertical deviations as well as distance to the threshold crossing point of the selected FAS and an integrity flags. Concerning the frequency selection, it tunes to the correct frequency using a channel number consisting of five numeric characters. The channel number enables the airborne subsystem to also select the Final Approach Segment (FAS) data block that defines the correct approach. The correct FAS data block is selected by the Reference Path Data Selector (RPDS) which is included as part of the FAS definition data in one of the broadcast message. In order to

minimize impact upon current aircraft design and operational procedures, guidance information output is intended to be consistent with ILS requirements ("ILS look-alike"). This will reduce the certification effort of these Multi-Mode Receivers (MMR), of which the GBAS aircraft subsystem forms a part.

### 3 - Milano Linate GMS – Ground Monitoring Station

For this research we worked on the Milano - Linate Ground Monitoring Station (AS 670). In this phase of GBAS project its SIS (Signal In Space) is continually monitored from Ground Station that acts as an air - user

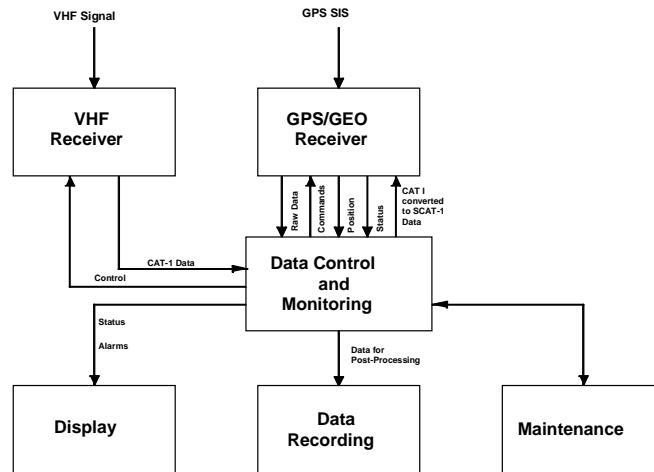

Figure 3 - GMS overview

The GMS system consists of four primary subsystems, showed in the Figure 3:

- GNSS receiver, that receive the SIS and converts it in an appropriate format;
- VHF receiver, that receive the GBAS – CAT I messages transmitted from a GBAS Reference station ;
- Local Control Unit that combines corrections and GNSS receiver measures, computes in real time the GMS position and compares this with a reference one;
- Data Recording Unit that stores the data sets of measures in removable disks.

In this way the GMS gives an indication on GBAS working.

### 4 - General approach to the Protection Level

[1][6]The accuracy of a navigation system is defined in term of Total System Error TSE which is referenced to a required flight path defined for each phase of flight. To follow the required path, the aircraft navigation system estimates the aircraft's position and generates commands (either to a cockpit display or to the autopilot). Errors in the estimation of the aircraft's position is referred to as Navigation System Error NSE which is the difference between the aircraft's true position and its displayed position (see figure 4).

The difference between the required flight path and the displayed position of the aircraft is called Flight Technical Error FTE and contains aircraft dynamics, turbulence effects, man-machine-interface problems, etc.

The vector sum of the NSE and the FTE is the Total System Error. Since the actual Navigation System Error can not be observed without a high-precision reference system (the NSE is the difference between the actual position of an aircraft and its computed position), an approach has to be found with which an upper bound can be found for this error.

The Horizontal Protection Level HPL is the radius of a circle in the horizontal plane (the plane tangent to the WGS84 ellipsoid), with the centre being at the true aircraft position, which describes the region which is assured to contain the indicated horizontal position. It is the horizontal region for which the missed alert requirements can be met.

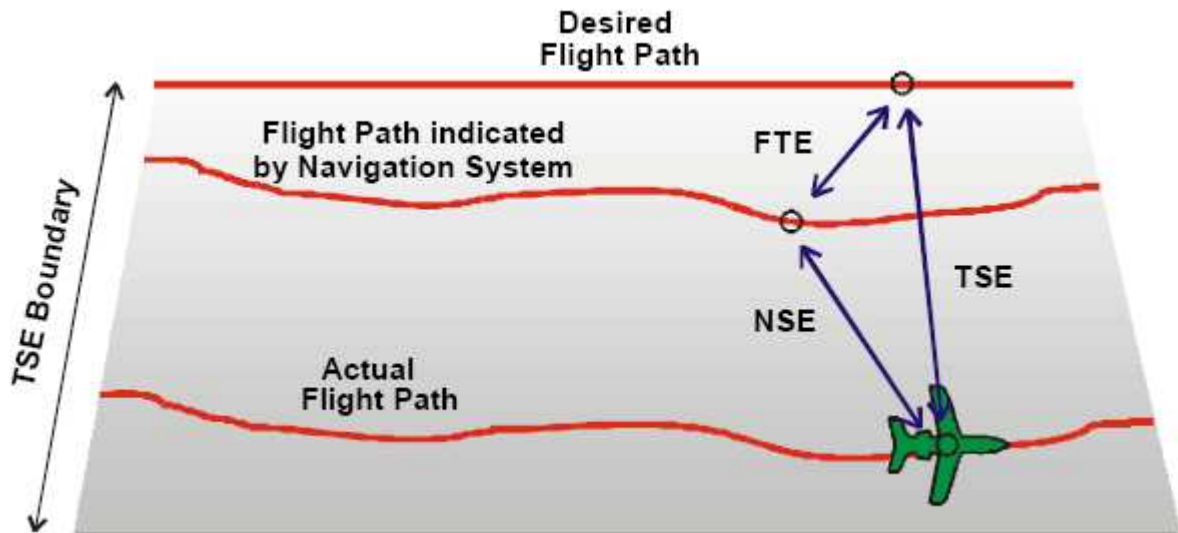

**Figure 4** - Navigation System Error, Flight Technical Error and Total System Error [1]

The Vertical Protection Level VPL is the half length of a segment on the vertical axis (perpendicular to the horizontal plane of the WGS84 ellipsoid), with the centre being at the true aircraft position, which describes the region which is assured to contain the indicated vertical position. It is the vertical region for which the missed alert requirements can be met.

The protection levels are a function of the satellite constellation and the estimated SBAS performance. Thus, using the GBAS correction data, the protection levels can be determined without using actual pseudorange measurements.

The computed protection levels must be compared to the required Alert Limits AL for the particular phase of flight. If the protection level is smaller than the required alert limit, then the phase of flight can be performed. However, if the protection level is greater than or equal to the required alert limit, then the integrity of the position solution can not be guaranteed in the context of the requirements for that particular flight phase.

$$XPL < XAL \text{ Integrity can be assured}$$

$$XPL \geq XAL \text{ Integrity can not be assured}$$

with XPL (horizontal or vertical) protection level and XAL (horizontal or vertical) alert limit

## 5 - Results

We start from a 24h data set of measurements carried out by the GMS on 5th September 2005. The post processing software used was PEGASUS v 4.1 developed from EUROCONTROL. The horizontal deviation is showed in the following figure 5:

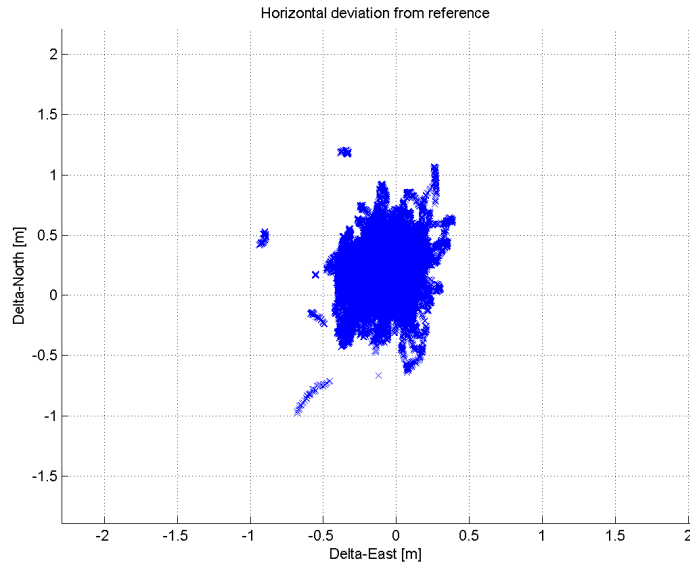

**Figure 5 – Horizontal Deviation**

This distribution shows that all the errors fall in the range  $\pm 1$  meter . The largest errors arise when the GBAS correction are not applied.

In order to verify the Integrity requirement another check is run. In the following figure we compare the protection levels and its relative position errors.

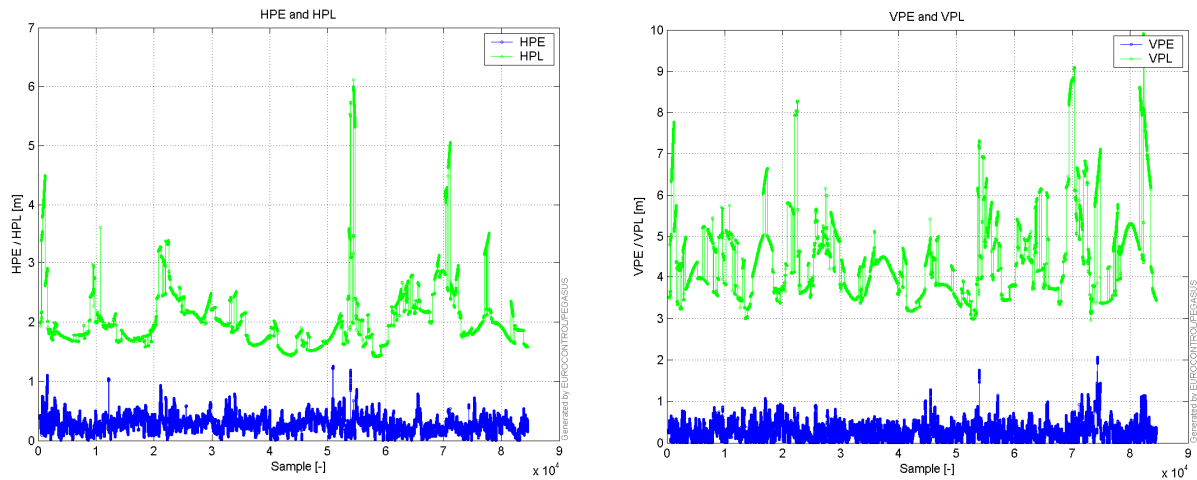

**Figure 6 – Protection Level and Position Error**

From the above pictures, it's easy to check that integrity is always verified.

Finally, we report the Probability distribution both of the Horizontal and Vertical Position Errors and their respective Protection Levels (see figure 7 and 8) .

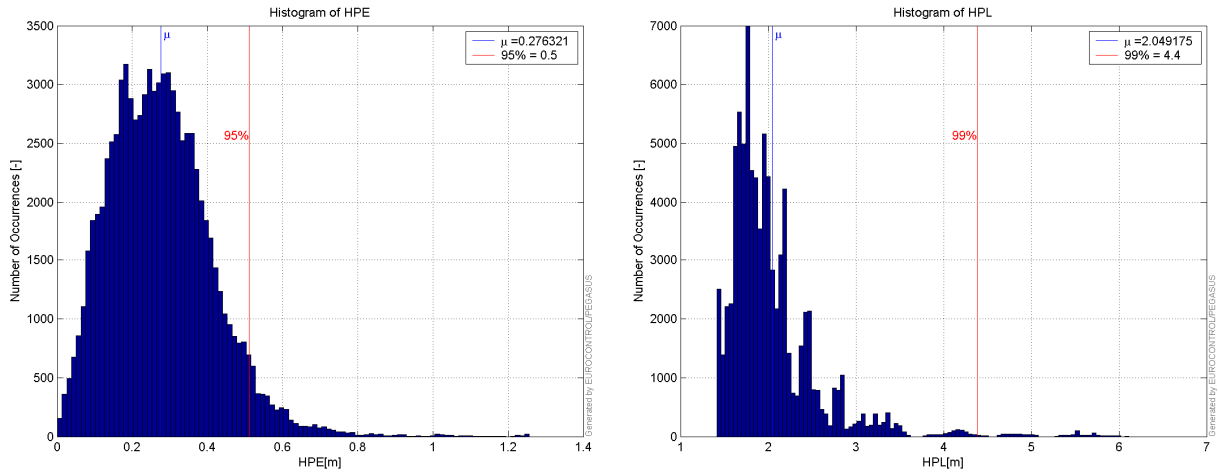

**Figure 7 – Histograms of HPE and HPL**

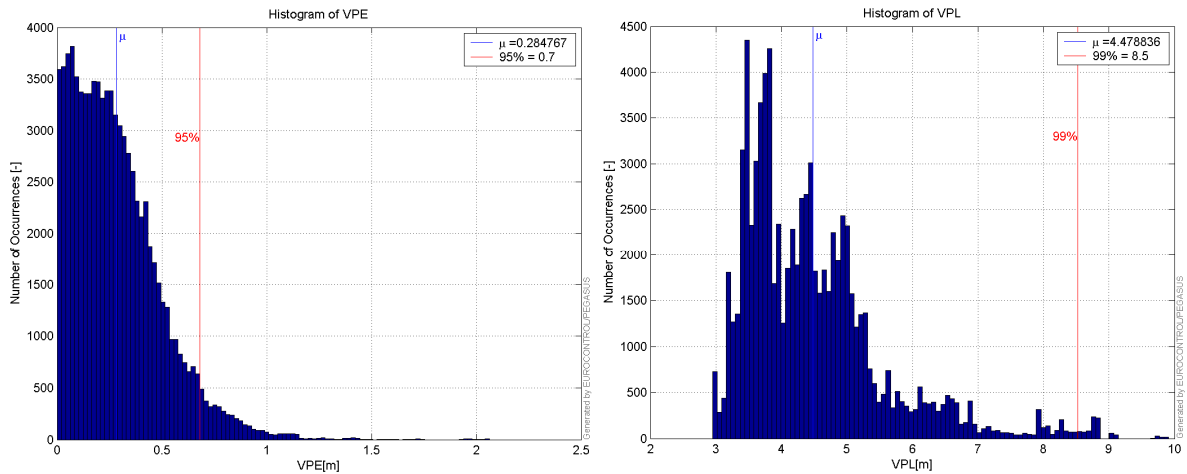

**Figure 8 – Histograms of VPE and VPL**

From the statistical analysis the following results arise:

**Table 2 – Statistical Analysis**

	$\mu$ (m)	95% (m)
<b>HPE</b>	0.276321	0.5
<b>HPL</b>	2.049175	4.4
<b>VPE</b>	0.284767	0.7
<b>VPL</b>	4.478636	8.5

## 6 – Conclusion

In this paper we processed the data set of measures collected in the unique Italian GBAS Installation with the software Pegasus v 4.1 currently regarded a benchmark in the European research. This is the first attempt to develop these procedures in the Italian context.

A set of statistical test are run in order to verify its efficiency. We showed that all the tests comply with flight category CAT-I requirements.

Table 1 and Table2 show that the CAT – I Horizontal and Vertical Accuracies are largely satisfied.

This is partly due to the static mode (fixed position) of the instruments. A further development of this research could investigate the implication of a dynamic positioning. A comparison between different augmentation system (SBAS and GBAS) also should be of interest.

The authors are grateful to ENAV SpA and Thales - Milano for providing facilities.

## **References**

- [1] PEGASUS\*Plus Technical Notes, EUROCONTOL
- [2] Minimum Operational Performance Standards for Airborne Supplemental Navigation Equipment Using GPS, RTCA Document 208, July 1991
- [3] RTCA: Minimal Operational Performance Standards for GPS/WAAS Airborne Equipment, Doc. No. Do 229 A, June 1998
- [4] MARS3 Technical Notes for Pegasus, rif. PEG-GBAS-TN02
- [5] ESA EGNOS web pages <http://www.esa.int/export/esaEG/estb.html>
- [6] S. GAGLIONE, T. COZZOLINO: ESTB – EGNOS System Test Bed, Atti Istituto Italiano di Navigazione IIN, Roma 2004